

# Agilent 4395A Network/Spectrum/Impedance Analyzer

## Data Sheet

### Network Measurement

Specifications describe the instrument's warranted performance over the temperature range of 0 °C to 40 °C (except as noted). Supplemental characteristics are intended to provide information that is useful in applying the instrument by giving non-warranted performance parameters. These are denoted as *SPC* (*supplemental performance characteristics*), *typical*, or *nominal*. Warm up time must be greater than or equal to 30 minutes after power on for all specifications.

#### Source characteristics

##### Frequency characteristics (Option 4395A-800)

**Range** ..... 10 Hz to 500 MHz

**Resolution** ..... 1 mHz

##### Frequency reference

###### Accuracy

at 23 °C ± 5 °C, referenced to 23 °C ..... < ±5.5 ppm

###### Aging

..... < ±2.5 ppm/year (SPC)

###### Initial achievable accuracy

..... < ± 1.0 ppm (SPC)

###### Temperature stability

at 23 °C ± 5 °C, referenced to 23 °C ..... < ±2ppm (SPC)

##### Precision frequency reference (Option 4395A-1D5)

###### Accuracy

at 0 °C to 40 °C, referenced to 23 °C ..... < ±0.13 ppm

###### Aging

..... < ±0.1 ppm/year (SPC)

###### Initial achievable accuracy

..... < ±0.02 ppm (SPC)

###### Temperature stability

at 0 °C to 40 °C, referenced to 23 °C ..... < ±0.01 ppm (SPC)

#### Output characteristics

**Power range** ..... -50 dBm to + 15 dBm

##### Level accuracy

at 0 dBm output, 50 MHz, 23 °C ± 5 °C, ..... ±1.0 dB

##### Level linearity

Output power	Linearity <sup>1</sup>
≥ -40 dBm	±1.0 dB
< -40 dBm	±1.5 dB

1. At relative to 0 dBm output, 50 MHz,  
23 °C ± 5 °C



# Network Measurement

*continued*

<b>Flatness</b>	
at 0 dBm output, relative to 50 MHz, 23 °C ± 5 °C	±2 dB
<b>Resolution</b>	0.1 dB
<b>Spectral purity characteristics</b>	
<b>Harmonics</b>	
at +10 dBm output	< -30 dBc
<b>Non-harmonics spurious</b>	
at +10 dBm output	< -30 dBc
<b>Noise sidebands</b>	
at ≥ 10 kHz offset from carrier	< -95 dBc/Hz
<b>Power sweep range</b>	20 dB max.
<b>Power sweep linearity</b>	
deviation from linear power referenced to the stop power level	±0.5 dB
<b>Impedance</b>	50 Ω nominal
<b>Return loss</b>	
frequency ≤ 200 MHz	> 15 dB (SPC)
frequency > 200 MHz	> 7dB (SPC)
<b>Connector</b>	Type N female

---

# Receiver Characteristics

## Input characteristics

**Frequency range** .....10 Hz to 500 MHz

**Input attenuator** .....0 to 50 dB, 10 dB step

### Full scale input level (R, A, B)

Attenuator setting (dB)	Full scale input level
0	-10 dBm
10	0 dBm
20	+10 dBm
30	+20 dBm
40	+30 dBm
50	+30 dBm

**IF bandwidth (IFBW)** 2, 10, 30, 100, 300, 1 k, 3 k, 10 k, 30 kHz

*Note: The IFBW should be set to less than 1/5 of the lowest frequency in the sweep range.*

### Noise level (referenced to full scale input level, 23 °C ± 5 °C)

at 10 Hz ≤ frequency < 100 Hz, IFBW = 2 Hz .....-85 dB (SPC)

at 100 Hz ≤ frequency < 100 kHz, IFBW = 10 Hz .....-85 dB

at 100 kHz ≤ frequency, IFBW = 10 Hz .....-115 dB

### Input crosstalk

for input R + 10 dBm input, input attenuator: .....20 dB

for input A, B input attenuator: .....0 dB

at < 100 kHz

R through A, B .....< -100 dB

others .....< -100 dB (SPC)

at ≥ 100 kHz

R through A, B .....< -120 dB

others .....< -120 dB (SPC)

### Source crosstalk (for input A, B)(typical for input R)

at + 10 dBm output, < 100 kHz, input attenuator: 0 dB .....< -100 dB

at + 10 dBm output, ≥100 kHz, input attenuator: 0 dB .....< -120 dB

### Multiplexer switching impedance change

at input attenuator 0 dB .....< 0.5% (SPC)

at input attenuator 10 dB and above .....< 0.1% (SPC)

**Connector** .....Type-N female

**Impedance** .....50 Ω nominal

### Return loss

	Input attenuator		
	0 dB	10 dB	20 dB to 50 dB
10 Hz ≤ frequency < 100 kHz	25 dB <sup>1</sup>	25 dB <sup>1</sup>	25 dB <sup>1</sup>
100 kHz ≤ frequency ≤ 100 MHz	25 dB <sup>1</sup>	25 dB	25 dB <sup>1</sup>
100 MHz < frequency	15 dB <sup>1</sup>	15 dB	15 dB <sup>1</sup>

**Maximum input level** +30 dBm (at input attenuator: 40 dB or 50 dB)

**Maximum safe input level** +30 dBm or ±7 Vdc (SPC)

1. SPC

# Magnitude Characteristics

## Absolute amplitude accuracy (R, A, B)

at -10 dBm input, input attenuator:

10 dB, frequency  $\geq 100$  Hz, IFBW  $\leq 3$  kHz, 23 °C  $\pm 5$  °C, ..... <  $\pm 1.5$  dB

## Ratio accuracy (A/R, B/R) (typical for A/B)

at -10 dBm input, input attenuator:

10 dB, IFBW  $\leq 3$  kHz, 23 °C  $\pm 5$  °C, ..... <  $\pm 2$  dB

## Dynamic accuracy (A/R, B/R) (typical for A/B)

Input level (relative to full scale input level)	Dynamic accuracy <sup>1</sup> frequency $\geq 100$ Hz
0 dB $\geq$ input level > -10 dB	$\pm 0.4$ dB
-10 dB $\geq$ input level $\geq$ -60 dB	$\pm 0.05$ dB
-60 dB > input level $\geq$ -80 dB	$\pm 0.3$ dB
-80 dB > input level $\geq$ -100 dB	$\pm 3$ dB

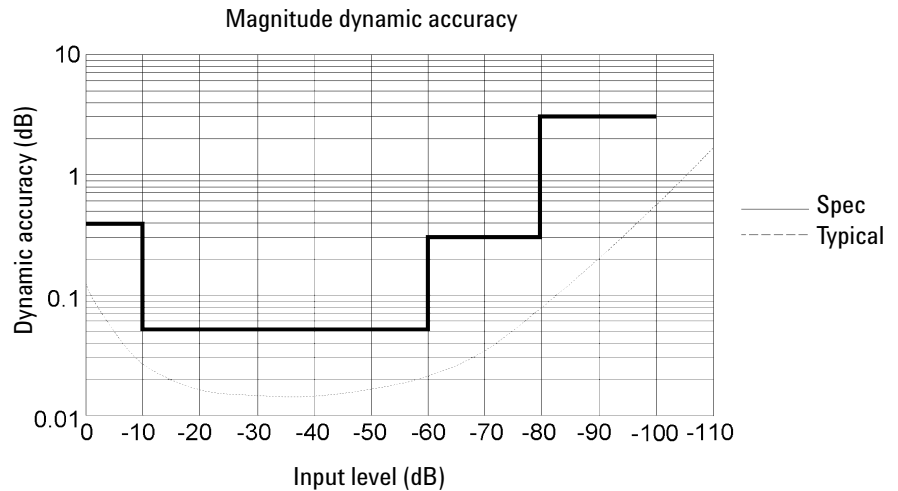

Figure 1-1. Magnitude dynamic accuracy

**Residual responses** ..... < -80 dB full scale (SPC)

## Trace noise (A/R, B/R, A/B)

at 50 MHz, both inputs:

full scale input level -10 dB, IFBW = 300 Hz ..... < 0.005 dB rms (SPC)

**Stability (A/R, B/R, A/B)** ..... <  $\pm 0.01$  dB/°C (SPC)

## Phase characteristics

**Measurements format** ..... Standard format, expanded phase format

## Frequency response (deviation from linear phase) (A/R, B/R) (SPC for A/B)

at -10 dBm input, input attenuator: 10 dB, IFBW  $\leq 3$  kHz, 23 °C  $\pm 5$  °C ..... <  $\pm 12^\circ$

## Dynamic accuracy (A/R, B/R) (SPC for A/B)

Input level (relative to full scale input level)	Dynamic accuracy <sup>1</sup> frequency $\geq 100$ Hz
0 dB $\geq$ input level > -10 dB	$\pm 3^\circ$
-10 dB $\geq$ input level $\geq$ -60 dB	$\pm 0.3^\circ$
-60 dB > input level $\geq$ -80 dB	$\pm 1.8^\circ$
-80 dB > input level $\geq$ -100 dB	$\pm 18^\circ$

1. R input level (B input level for A/B) = full scale input level -10 dB, IFBW = 10 Hz, 23 °C  $\pm 5$  °C

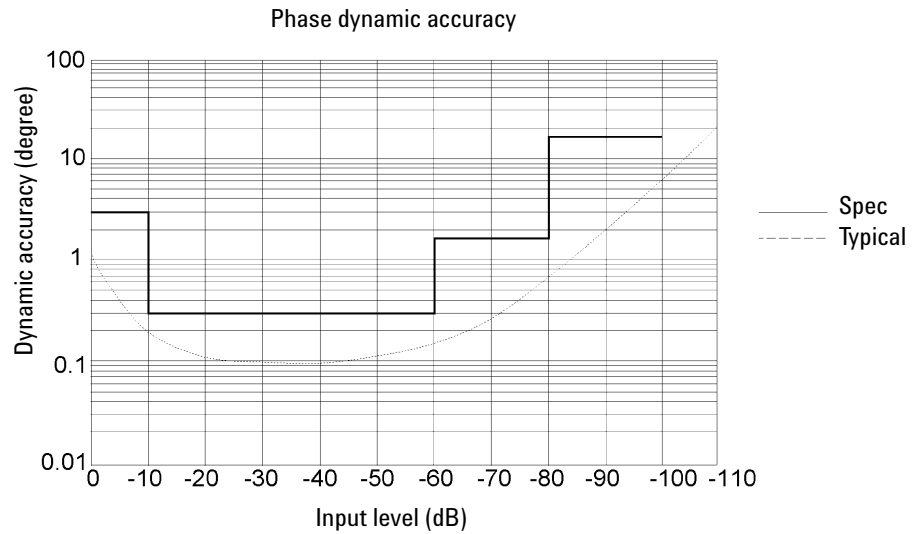

**Figure 1-2. Phase dynamic accuracy**

**Trace noise (A/R, B/R, A/B)**

at 50 MHz, both inputs:

full scale input level -10 dB, IFBW = 300 Hz ..... < 0.04° rms (SPC)

**Stability (A/R, B/R, A/B)** ..... < ±0.1 °/°C (SPC)

**Group delay characteristics**

**Aperture [Hz]** ..... 0.25% to 20% of span

**Accuracy**

In general, the following formula can be used to determine the accuracy, in seconds, of a specific group delay measurement:

$$\text{Accuracy (seconds)} = \frac{\text{Phase accuracy (degree)}}{\text{Aperture(Hz)} \times 360 \text{ (degree)}}$$

**Sweep characteristics**

**Sweep type** ..... Linear frequency, log frequency, power, list frequency

**Sweep direction** ..... Upper direction only

**Trigger type** ..... Hold, single, number of groups, continuous

**Trigger source** ..... Internal (free run), external, manual, GPIB (bus)

**Event trigger** ..... On point, on sweep

# Spectrum Measurement

## Frequency characteristics

**Frequency range** .....10 Hz to 500 MHz

**Frequency readout accuracy**  
 .....  $\pm((freq\ readout[Hz]) \times (freq\ ref\ accuracy[1]) + RBW[Hz] + \frac{SPAN[Hz]}{NOP-1}) [Hz]$   
 where NOP means number of display points

### Frequency reference (Option 4395A-800)

**Accuracy**  
 at 23 °C ± 5 °C, referenced to 23 °C ..... < ±5.5 ppm

**Aging** ..... < ±2.5 ppm/year (SPC)

**Initial achievable accuracy** ..... < ± 1.0 ppm (SPC)

**Temperature stability**  
 at 23 °C ± 5 °C, referenced to 23 °C ..... < ±2 ppm (SPC)

### Precision frequency reference (Option 4395A-1D5)

**Accuracy**  
 at 0 °C to 40 °C, referenced to 23 °C ..... < ±0.13 ppm

**Aging** ..... < ±0.1 ppm/year (SPC)

**Initial achievable accuracy** ..... < ±0.02 ppm (SPC)

**Temperature stability**  
 at 0 °C to 40 °C, referenced to 23 °C ..... < ±0.01 ppm (SPC)

### Resolution bandwidth (RBW)

**Range**  
 3 dB RBW at span > 0 .....1 Hz to 1 MHz, 1-3 step  
 3 dB RBW at span = 0  
 ..... .3 k, 5 k, 10 k, 20 k, 40 k, 100 k, 200 k, 400 k, 800 k, 1.5 M, 3 M, 5 MHz

**Selectivity (60 dB BW/3 dB BW)**  
 at span > 0 ..... < 3

**Mode** ..... Auto or manual

**Accuracy**  
 at span > 0 ..... < ±10%  
 at span = 0 ..... < ±30%

### Video bandwidth (VBW)

**Range**  
 at span > 0 ..... .3 MHz to 3 MHz, 1-3 step,  $0.003 \leq VBW/RBW \leq 1$

### Noise sidebands

Offset from carrier	Noise sidebands
≥ 1 kHz	< -95 dBc/Hz
≥ 100 kHz	< -108 dBc/Hz

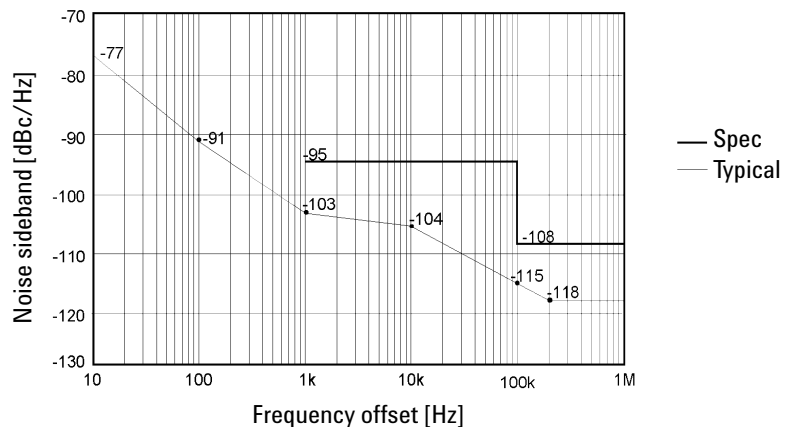

Figure 1-3. Noise sidebands

# Amplitude Characteristics

**Amplitude range** .....displayed average noise level to +30 dBm

**Reference value setting range** .....-100 dBm to +30 dBm

**Level accuracy**

at -20 dBm input, 50 MHz, input attenuator: 10 dB, 23 °C ± 5 °C ..... < ±0.8 dB

**Frequency response**

at -20 dBm input, input attenuator: 10 dB, referenced to level at 50 MHz, 23 °C ± 5 °C

frequency ≥ 100 Hz ..... < ±1.5 dB

frequency < 100 Hz ..... < ±1.3 dB

**Amplitude fidelity<sup>1</sup>**

**Log scale<sup>2</sup>**

Range (dB to reference input level [dB])	Amplitude fidelity [dB]
0 to -30	±0.05
-30 to -40	±0.07
-40 to -50	±0.15
-50 to -60	±0.35
-60 to -70	±0.8
-70 to -80	±1.8

**Linear scale<sup>2</sup>** ..... < ±3%

**Displayed average noise level**

at reference value ≤ -40 dBm, input attenuator: auto or 0 dB

at frequency ≥ 1 kHz ..... -120 dBm/Hz

at ≥ 100 kHz ..... -133 dBm/Hz

at ≥ 10 MHz ..... (-145 + frequency/100 MHz) dBm/Hz<sup>3</sup>

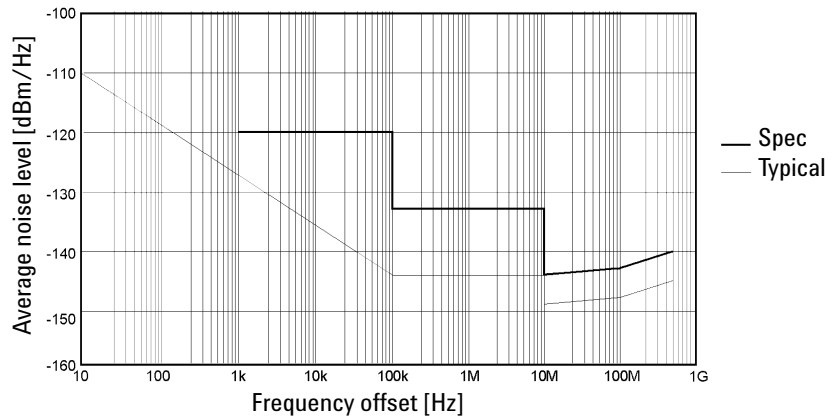

**Figure 1-4. Typical displayed average noise level**

1. Fidelity shows an extent of nonlinearity referenced to the reference input level.
2. RBW = 10 Hz, -20 dBm ≤ reference value ≤ +30 dBm, reference input level = full scale input level -10 dB, 23 ± 5 °C
3. At start frequency ≥ 10 MHz

*Note: Refer to Input attenuator part for the definition of full scale input level.*

# On-screen Dynamic Range

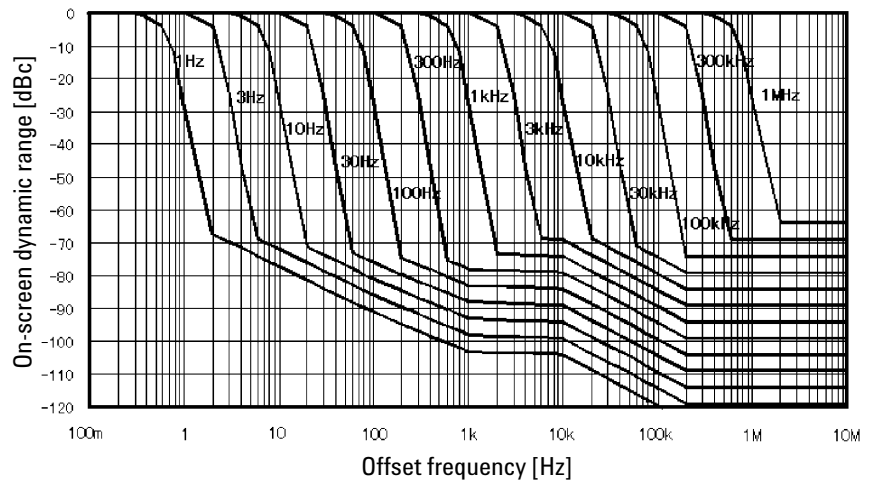

Figure 1-5. Typical on-screen dynamic range (center: 100 MHz)

## Spurious responses

### Second harmonic distortion

at single tone input with full scale input level  $-10$  dB, input signal frequency  $\geq 100$  kHz  
 .....  $< -70$  dBc,  $< -75$  dBc (SPC)

### Third order inter-modulation distortion

at two tones input with full scale input level  $-16$  dB, separation  $\geq 100$  kHz  
 .....  $< -75$  dBc,  $< 80$  dBc (SPC)

### Spurious

at single tone input with full scale input level  $-10$  dB, input signal frequency  $\leq 500$  MHz  
 .....  $< -75$  dBc

except for the following frequency ranges:

$5.6$  MHz  $\pm 1$  MHz,  $30.6$  MHz  $\pm 1$  MHz,  $415.3$  MHz  $\pm 1$  MHz

### Residual response

at reference value setting  $\leq -40$  dBm, input attenuator: auto or 0 dB .....  $< -110$  dBm



# Typical Dynamic Range

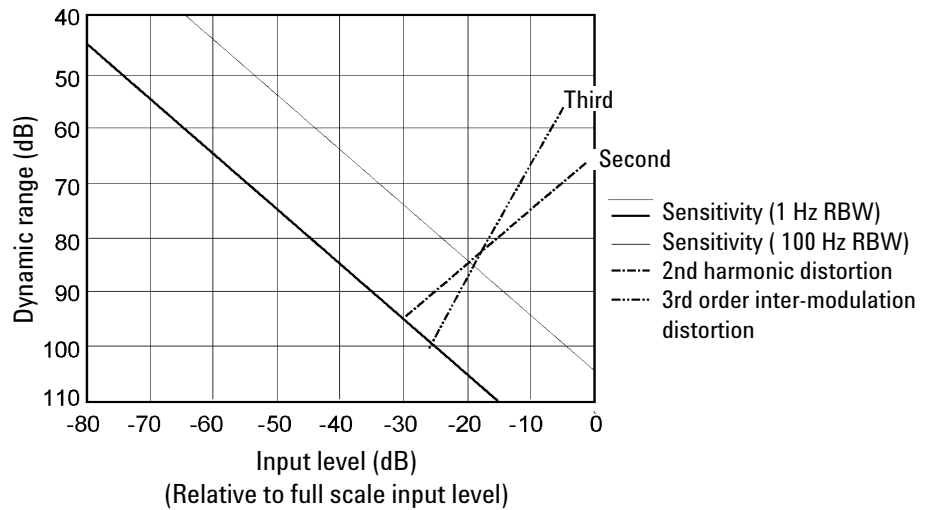

Figure 1-6. Typical dynamic range at inputs R, A, and B

### Input attenuator

Setting range ..... 0 dB to 50 dB, 10 dB step

Attenuator setting (dB)	Full scale input level
0	-20 dBm
10	-10 dBm
20	0 dBm
30	+10 dBm
40	+20 dBm
50	+30 dBm

Mode ..... Auto or manual

(In auto mode, the attenuator is set to 20 dB above the reference value; this ensures that the maximum signal level after the attenuator will not be greater than -20 dBm.)

### Input attenuator switching uncertainty

at attenuator:  $\leq 30$  dB, referenced to 10 dB .....  $< \pm 1.0$  dB

at attenuator:  $\geq 40$  dB, referenced to 10 dB .....  $< \pm 1.5$  dB

Temperature drift .....  $< \pm 0.05$  dB/ $^{\circ}$ C (SPC)

### Scale

Log 0.1 dB/div to 20 dB/div

#### Linear

at watt .....  $1.0 \times 10^{-12}$  W/div

at volt .....  $1.0 \times 10^{-9}$  V/div

Measurement format ..... Spectrum or noise (/Hz)

Display unit ..... dBm (unit of marker: dBm, dBV, dB $\mu$ V, V, W)

### Sweep characteristics

Sweep type ..... Linear, list

Trigger type ..... Hold, single, number of groups, continuous

Trigger source ..... Internal (free run), external, manual, level gate, edge gate, GPIB (bus)

Sweep time (excluding each sweep setup time)

RBW	SPAN	Typical sweep time
1 MHz	500 MHz	190 ms
100 kHz	100 MHz	300 ms
10 kHz	10 MHz	240 ms
1 kHz	1 MHz	190 ms
100 Hz	100 kHz	270 ms
10 Hz	10 kHz	2.0 s
1 Hz	1 kHz	11 s
—	Zero Span	— <sup>1</sup>

1. See the next item for sweep time at zero span

**Zero span**

<b>RBW</b>	<b>Minimum resolution</b>	<b>Maximum sweep time</b>
5 MHz	40 ns	1.28 ms
100 kHz	1.28 $\mu$ s	81.92 ms
3 kHz	40.96 $\mu$ s	2.62 s

**Number of display points**

at span > 0 ..... 2 to 801 points (automatically set)  
 at span = 0 ..... 2 to 801 points (selectable)

**Input characteristics**

**Input port** ..... R, A, B

**Crosstalk**

from any input to other inputs, at the same input attenuator settings < -100 dB (SPC)

**Connector** ..... Type N female

**Impedance** ..... 50  $\Omega$  nominal

**Return loss**

	<b>Input attenuator</b>		
	<b>0 dB</b>	<b>10 dB</b>	<b>20 dB to 50 dB</b>
10 Hz $\leq$ frequency < 100 kHz	25 dB <sup>1</sup>	25 dB <sup>1</sup>	25 dB <sup>1</sup>
100 kHz $\leq$ frequency $\leq$ 100 MHz	25 dB <sup>1</sup>	25 dB	25 dB <sup>1</sup>
100 MHz < frequency	15 dB <sup>1</sup>	15 dB	15 dB <sup>1</sup>

**Input level** ..... +30 dBm max. at input attenuator: 50 dB

**Maximum safe input level** ..... +30 dBm or  $\pm 7$  Vdc (SPC)

# Specifications when Option 4395A-1D6 Time-Gated Spectrum Analysis is Installed

All specifications are identical to the standard Agilent 4395A except the following items.

<b>Gate length</b>	
<b>Range</b> .....	.6 $\mu$ s to 3.2 s
<b>Resolution</b>	
<b>Range of gate length (<math>T_1</math>)</b>	<b>Resolution</b>
6 $\mu$ s $\leq T_1 \leq$ 25 ms	0.4 $\mu$ s
25 ms $< T_1 \leq$ 64 ms	1 $\mu$ s
64 ms $< T_1 \leq$ 130 ms	2 $\mu$ s
130 ms $< T_1 \leq$ 320 ms	5 $\mu$ s
320 ms $< T_1 \leq$ 1.28 s	20 $\mu$ s
1.28s $< T_1 \leq$ 3.2 s	100 $\mu$ s
<b>Gate length</b>	
<b>Range</b> .....	.2 $\mu$ s to 3.2 s
<b>Resolution</b>	
<b>Range of gate delay (<math>T_d</math>)</b>	<b>Resolution</b>
2 $\mu$ s $\leq T_d \leq$ 25 ms	0.4 $\mu$ s
25 ms $< T_d \leq$ 64 ms	1 $\mu$ s
64 ms $< T_d \leq$ 130 ms	2 $\mu$ s
130 ms $< T_d \leq$ 320 ms	5 $\mu$ s
320 ms $< T_d \leq$ 1.28 s	20 $\mu$ s
1.28 s $< T_d \leq$ 3.2 s	100 $\mu$ s
<b>Additional amplitude error</b>	
<b>Log scale</b> .....	< 0.3 dB (SPC)
<b>Linear scale</b> .....	< 3% (SPC)
<b>Gate control modes</b> .....	.Edge (positive/negative) or level
<b>Gate trigger input</b> (external trigger input is used)	
<b>Connector</b> .....	.BNC female
<b>Level</b> .....	.TTL
<b>Gate output</b>	
<b>Connector</b> .....	.BNC female
<b>Level</b> .....	.TTL

---

# Option 4395A-010 Impedance measurement

The following specifications are applied when the 43961A impedance test kit is connected to the 4395A.

## Measurement functions

Measurement parameters  
Display parameters

Z, Y, L, C, Q, R, X, G, B,  $\theta$   
|Z|,  $\theta_z$ , R, X, |Y|,  $\theta_y$ , G, B, | $\Gamma$ |,  $\theta_\Gamma$ ,  $\Gamma_x$ ,  $\Gamma_y$ , Cp, Cs,  
Lp, Ls, Rp, Rs, D, Q

## Display formats

- Vertical lin/log scale
- Complex plane
- Polar/Smith/admittance chart

## Sweep parameters

- Linear frequency sweep
- Logarithmic frequency sweep
- List frequency sweep
- Power sweep (in dBm unit)

## IF bandwidth

- 2,10, 30, 100, 300, 1k, 3k, 10k, 30k [Hz]

## Calibration

- OPEN/SHORT/LOAD 3 term calibration
- Fixture compensation
- Port extension correction

## Measurement port type

- 7-mm

## Output characteristics

**Frequency range** .....100 kHz to 500 MHz

**Frequency resolution** .....1 MHz

**Output impedance** .....50  $\Omega$  nominal

### Output level

when the measurement port is terminated by 50  $\Omega$ <sup>1</sup> .....-56 to +9 dBm

when the measurement port is open .....0.71 mVrms to 1.26 Vrms

**Resolution** .....0.1 dBm

**Level accuracy** ..... $\pm (A + B + 6 \times F / (1.8 \times 10^9))$ dB

Where

A = 2 dB

B = 0 dB (at 0 dBm  $\leq$  P  $\leq$  + 15 dBm)

or B = 1 dB (at -40 dBm  $\leq$  P < 0 dBm)

or B = 2 dB (at -50 dBm  $\leq$  P < -40 dBm)

F is setting frequency [Hz], P is output power setting

1. When the measurement port is terminated with 50  $\Omega$ , the signal level at the measurement port is 6 dB lower than the signal level at the RF OUT port.

# Measurement

## Basic Accuracy

(Supplemental performance characteristics)

Measurement accuracy is specified at the connecting surface of the 7-mm connector of the Agilent 43961A under the following conditions:

- Warm up time** ..... > 30 minutes
- Ambient temperature** ..... 23 °C ± 5 °C,  
within ±1 °C from the temperature at which calibration is performed
- Signal level (setting)** ..... 0 to +15 dBm
- Correction** ..... ON
- IFBW (for calibration and measurement)** ..... ≤ 300 Hz
- Averaging factor (for calibration and measurement)** ..... ≥ 8

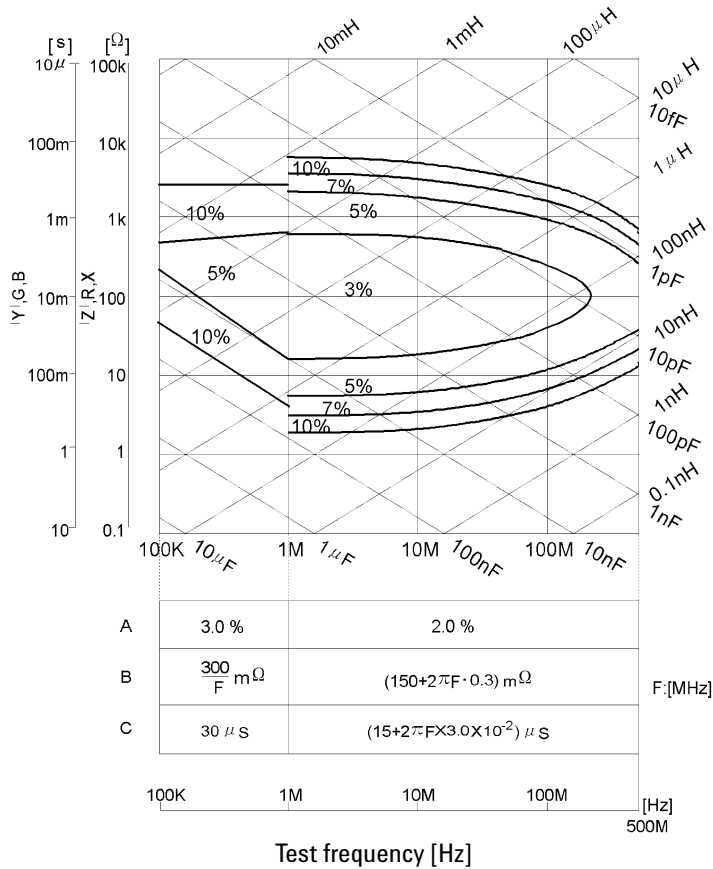

Figure 1-7. Impedance measurement accuracy

### IZI - θ accuracy

IZI accuracy  $Z_a = A + (B/|Z_m| + C \times |Z_m|) \times 100$  [%]

θ accuracy  $\theta_a = \sin^{-1}(Z_a/100)$

Where,  $|Z_m|$  is IZI measured. A, B, and C are obtained from Figure 1-7.

### IYI - θ accuracy

IYI accuracy  $Y_a = A + (B \times |Y_m| + C/|Z_m|) \times 100$  [%]

θ accuracy  $\theta_a = \sin^{-1}(Y_a/100)$

Where,  $|Y_m|$  is IYI measured. A, B, and C are obtained from Figure 1-7.

**R - X accuracy (depends on D)**

Accuracy	$D \leq 0.2$	$0.2 < D \leq 5$	$5 < D$
$R_a$	$\pm X_m \times X_a / 100 [\Omega]$	$R_a / \cos\theta [\%]$	$R_a [\%]$
$X_a$	$X_a [\%]$	$X_a / \sin\theta [\%]$	$\pm R_m \times R_a / 100 [\Omega]$

Where,

D can be calculated as:  $R/X$ , or  
 $R / (2\pi f \times L_s)$ , or  
 $R \times 2\pi f \times C_s$

$\theta$  can be calculated as:  $\tan^{-1}(X/R)$ , or  
 $\tan^{-1}(2\pi f \times L_s / R)$ , or  
 $\tan^{-1}(1 / (R \times 2\pi f \times C_s))$

$$R_a = A + (B/|R_m| + C \times |R_m|) \times 100 [\%]$$

$$X_a = A + (B/|X_m| + C \times |X_m|) \times 100 [\%]$$

$R_m$  and  $X_m$  are the measured R and X, respectively. A, B, and C are obtained from Figure 1-7.

**G - B accuracy (depends on D)**

Accuracy	$D \leq 0.2$	$0.2 < D \leq 5$	$5 < D$
$G_a$	$\pm B_m \times B_a / 100 [S]$	$G_a / \cos\theta [\%]$	$G_a [\%]$
$B_a$	$B_a [\%]$	$B_a / \sin\theta [\%]$	$\pm G_m \times G_a / 100 [\Omega]$

Where,

D can be calculated as:  $G/B$ , or  
 $G / (2\pi f \times C_p)$ , or  
 $G \times 2\pi f \times L_p$

$\theta$  can be calculated as:  $\tan^{-1}(B/G)$ , or  
 $\tan^{-1}(2\pi f \times C_p / G)$ , or  
 $\tan^{-1}(1 / (G \times 2\pi f \times L_p))$

$$G_a = A + (B/|G_m| + C \times |G_m|) \times 100 [\%]$$

$$B_a = A + (B/|B_m| + C \times |B_m|) \times 100 [\%]$$

$G_m$  and  $B_m$  are the measured G and B, respectively. A, B, and C are obtained from Figure 1-7.

**D accuracy**

Accuracy	$D \leq 0.2$	$0.2 < D$
$D_a$	$Z_a / 100$	$(Z_a / 100) \times (1 + D^2)$

Where,  $Z_a$  is |Z| accuracy.

**L accuracy (depends on D)**

Accuracy	$D \leq 0.2$	$0.2 < D$
$L_a$	$L_a / 100$	$L_a (1 + D)$

Where,  $L_a = A + (B/|Z_l| + C \times |Z_l|) \times 100 [\%]$

$|Z_l| = 2\pi f \times L_m$ , f is frequency in Hz, and  $L_m$  is measured L. A, B, and C are obtained from Figure 1-7.

**C accuracy (depends on D)**

Accuracy	$D \leq 0.2$	$0.2 < D$
$C_a$	$C_a$	$C_a (1 + D)$

Where,  $C_a = A + (B/|Z_c| + C \times |Z_c|) \times 100 [\%]$

$|Z_c| = 2\pi f \times C_m$ , f is frequency in Hz, and  $C_m$  is measured C. A, B, and C are obtained from Figure 1-7.

# Common to Network/Spectrum/ Impedance Measurement

<b>Display</b>	
<b>LCD</b>	
Size/type	.8.4 inch color LCD
Number of pixels	.640 x 480
Effective display area	.160 mm x 115 mm(600 x 430 dots)
Number of display channels	.2
<b>Format single, dual (split or overwrite)</b>	
<b>Number of traces</b>	
For measurement	.2 traces
For memory	.2 traces
<b>Data math</b>	
	.gain x data – offset,
	gain x (data - memory) – offset,
	gain x (data + memory) – offset,
	gain x (data/memory ) – offset
<b>Data hold</b>	.Maximum hold, minimum hold
<b>Marker</b>	
<b>Number of markers</b>	
Main marker	.1 for each channel
Sub-marker	.7 for each channel
△ marker	.1 for each channel
<b>Hard copy</b>	
<b>Mode</b>	.Dump mode only (including color dump mode)
<b>Storage</b>	
<b>Built-in flexible disk drive</b>	
Type	.3.5 inch, 1.44 MByte, or 720 KByte, 1.44 MByte format is used for disk initialization
<b>Memory</b>	.512 KByte, can be backed up by flash memory
<b>GPIB</b>	
<b>Interface</b>	.IEEE 488.1-1987, IEEE 488.2-1987, IEC 625, and JIS C 1901-1987 standards compatible.
<b>Interface function</b>	.SH1, AH1, T6, TEO, L4, LEO, SR1, RL1, PP0, DC1, DT1, C1, C2, C3, C4, C11, E2
<b>Data transfer formats</b>	.ASCII, 32 and 64 bit IEEE 754 floating point format, DOS PC format (32 bit IEEE with byte order reversed)
<b>Printer parallel port</b>	
<b>Interface</b>	.IEEE 1284 Centronics standard compliant
<b>Printer control language</b>	.PCL3 printer control language
<b>Connector</b>	.D-SUB (25-pin)

**Option 4395A-001 DC voltage/current source**

The setting of Option 4395A-001 DC voltage/current source is independent of channel 1 and channel 2 settings.

**Voltage**

**Range** .....-40 V to +40 V

**Resolution** .....1 mV

**Current limitation**

at voltage setting = -25 V to +25 V .....±100 mA

at voltage setting = -40 V to -25 V, 25 V to 40 V .....±20 mA

**Current**

**Range** -20 µA to -100 mA, 20 µA to 100 mA

**Resolution** .....20 µA

**Voltage limitation**

at current setting = -20 mA to +20 mA .....±40 V

at current setting = -100 mA to -20 mA, 20 mA to 100 mA .....±25 V

**Accuracy**

**Voltage**

at 23 °C ± 5 °C .....±(0.1% + 4 mV + I<sub>dc</sub><sup>1</sup> [mA] × 5 [Ω] mV)

**Current**

at 23 °C ± 5 °C .....±(0.5% + 30 µA + V<sub>dc</sub><sup>2</sup> [V]/10 [kΩ] mA)

**Probe power**

**Output voltage** .....+15 V (300 mA), -12.6 V (160 mA), GND nominal

**Specifications when instrument BASIC is operated**

**Keyboard** ..... PS/2 style 101 English keyboard

**Connector** .....mini-DIN

**8 bit I/O port**

**Connector** .....D-SUB (15-pin)

**Level** .....TTL

**Number of input/output bit** .....4 bit for input, 8 bit for output

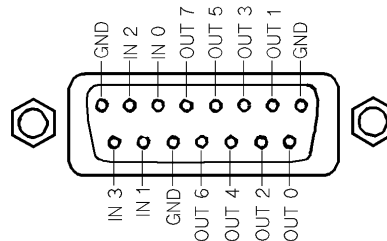

**Figure 1-8. 8 bit I/O port pin assignments**

**24-bit I/O interface**

**Connector** .....D-SUB (36-pin)

**Level** .....TTL

**I/O** .....8-bit for input or output, 16-bit for output

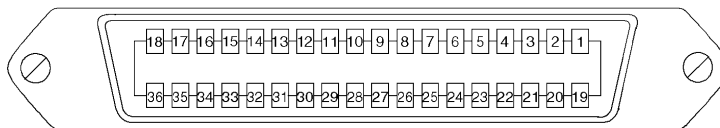

**Figure 1-9. 24-bit I/O interface pin assignment**

1. Current at DC source connector.  
2. Voltage at DC source connector.



**Table 1-1. Signal source assignment**

<b>Pin No.</b>	<b>Signal name</b>	<b>Signal standard</b>
1	GND	0 V
2	INPUT1	TTL level, pulse input (pulse width: 1 $\mu$ s or above)
3	OUTPUT1	TTL level, latch output
4	OUTPUT2	TTL level, latch output
5	OUTPUT PORT A0	TTL level, latch output
6	OUTPUT PORT A1	TTL level, latch output
7	OUTPUT PORT A2	TTL level, latch output
8	OUTPUT PORT A3	TTL level, latch output
9	OUTPUT PORT A4	TTL level, latch output
10	OUTPUT PORT A5	TTL level, latch output
11	OUTPUT PORT A6	TTL level, latch output
12	OUTPUT PORT A7	TTL level, latch output
13	OUTPUT PORT B0	TTL level, latch output
14	OUTPUT PORT B1	TTL level, latch output
15	OUTPUT PORT B2	TTL level, latch output
16	OUTPUT PORT B3	TTL level, latch output
17	OUTPUT PORT B4	TTL level, latch output
18	OUTPUT PORT B5	TTL level, latch output
19	OUTPUT PORT B6	TTL level, latch output
20	OUTPUT PORT B7	TTL level, latch output
21	I/O PORT C0	TTL level, latch output
22	I/O PORT C1	TTL level, latch output
23	I/O PORT C2	TTL level, latch output
24	I/O PORT C3	TTL level, latch output
25	I/O PORT D0	TTL level, latch output
26	I/O PORT D1	TTL level, latch output
27	I/O PORT D2	TTL level, latch output
28	I/O PORT D3	TTL level, latch output
29	PORT C STATUS	TTL level, input mode: LOW, output mode: HIGH
30	PORT D STATUS	TTL level, input mode: LOW, output mode: HIGH
31	WRITE STROBE SIGNAL	TTL level, active low, pulse output (width: 10 $\mu$ s; typical)
32	+5 V PULLUP	
33	SWEEP END SIGNAL	TTL level, active low, pulse output (width: 20 $\mu$ s; typical)
34	+5 V	+5 V, 100 mA MAX
35	PASS/FAIL SIGNAL	TTL level, PASS: HIGH, FAIL: LOW, latch output
36	PASS/FAIL WRITE STROBE SIGNAL	TTL level, active low, pulse output (width: 10 $\mu$ s; typical)

# General Characteristics

## Input and output characteristics

### External reference input

**Frequency** ..... 10 MHz  $\pm$  100 Hz (SPC)  
**Level** ..... -5 dBm to +5 dBm (SPC)  
**Input impedance** ..... 50  $\Omega$  nominal  
**Connector** ..... BNC female

### Internal reference output

**Frequency** ..... 10 MHz nominal  
**Level** ..... 0 dBm (SPC)  
**Output impedance** ..... 50  $\Omega$  nominal  
**Connector** ..... BNC female

### Reference oven output (Option 4395A-1D5)

**Frequency** ..... 10 MHz nominal  
**Level** ..... 0 dBm (SPC)  
**Output impedance** ..... 50  $\Omega$  nominal  
**Connector** ..... BNC female

### External trigger input

**Level** ..... TTL  
**Pulse width ( $T_p$ )** .....  $\geq 2 \mu\text{s}$  typically  
**Polarity** ..... positive/negative selective  
**Connector** ..... BNC female

### External program Run/Cont input

**Connector** ..... BNC female  
**Level** ..... TTL

### Gate output (Option 4395A-1D6)

**Level** ..... TTL  
**Connector** ..... BNC female

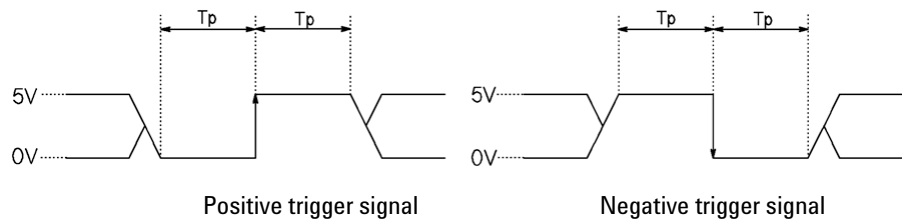

Figure 1-10. Trigger signal (external trigger input)

**S-parameter test set interface**

**Connector** .....D-SUB (25-pin)

**Caution**

Do not connect a printer to this connector. If you connect a printer with the S-parameter test set interface connector (TEST SET-I/O INTERCONNECT), it may cause damage to the printer.

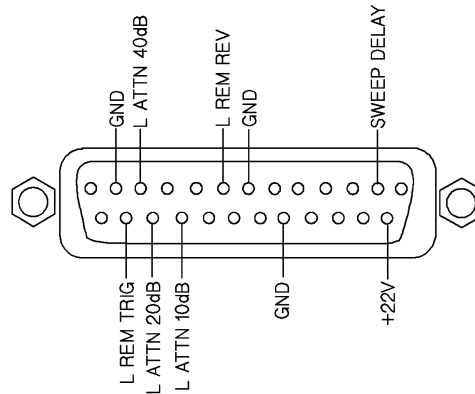

**Figure 1-11. S-parameter test set interface pin assignments**

**External monitor output**

**Connector** .....D-SUB (15-pin HD)

**Display resolution** .....640 x 480 VGA

**Operation conditions**

**Temperature**

Disk drive non-operating condition .....0 °C to 40 °C

Disk drive operating condition .....10 °C to 40 °C

**Humidity**

at wet bulb temperature ≤ 29 °C, without condensation

Disk drive non-operating condition .....15% to 95% RH

Disk drive operating condition .....15% to 80% RH

**Altitude** .....0 to 2,000 m

**Warm up time** .....30 minutes

**Non-operation conditions**

**Temperature** .....-20 °C to 60 °C

**Humidity**

at wet bulb temperature ≤ 45 °C, without condensation .....15% to 95% RH

**Altitude** .....0 to 4,572 m

**Others**

**EMC** .....Complies with CISPR 11 (1990) / EN 55011(1991) : Group 1, Class A

Complies with EN 50082-1 (1992) / IEC 1000-4-2 (1995) : 4 kV CD, 8 kV AD

Complies with EN 50082-1 (1992) / IEC 801-3 (1984) : 3 V/m

Complies with EN 50082-1 (1992) / IEC 1000-4-4 (1995) :1 kV / Main, 0.5kV /Signal line

Complies with IEC 1000-3-2 (1995) / EN 61000-3-2 (1995)

Complies with IEC 1000-3-3 (1994) / EN 61000-3-3 (1995)

**Safety** .....Complies with IEC 1010-1 (1990),

Amendment 1(1992), Amendment 2 (1995)

Certified by CSA-C22.2 No.1010.1-92

**Power requirements** .....90 V to 132 V, or 198 V to 264 V (automatically switched),

47 to 63 Hz, 300 VA max.

**Weight** .....21 kg (SPC)

**Dimensions** .....425 (W) x 235 (H) x 553 (D) mm



## Agilent Email Updates

[www.agilent.com/find/emailupdates](http://www.agilent.com/find/emailupdates)

Get the latest information on the products and applications you select.

### Agilent Technologies' Test and Measurement Support, Services, and Assistance

Agilent Technologies aims to maximize the value you receive, while minimizing your risk and problems. We strive to ensure that you get the test and measurement capabilities you paid for and obtain the support you need. Our extensive support resources and services can help you choose the right Agilent products for your applications and apply them successfully. Every instrument and system we sell has a global warranty. Support is available for at least five years beyond the production life of the product. Two concepts underlie Agilent's overall support policy: "Our Promise" and "Your Advantage."

#### Our Promise

Our Promise means your Agilent test and measurement equipment will meet its advertised performance and functionality. When you are choosing new equipment, we will help you with product information, including realistic performance specifications and practical recommendations from experienced test engineers. When you use Agilent equipment, we can verify that it works properly, help with product operation, and provide basic measurement assistance for the use of specified capabilities, at no extra cost upon request. Many self-help tools are available.

#### Your Advantage

Your Advantage means that Agilent offers a wide range of additional expert test and measurement services, which you can purchase according to your unique technical and business needs. Solve problems efficiently and gain a competitive edge by contracting with us for calibration, extra-cost upgrades, out-of-warranty repairs, and onsite education and training, as well as design, system integration, project management, and other professional engineering services. Experienced Agilent engineers and technicians worldwide can help you maximize your productivity, optimize the return on investment of your Agilent instruments and systems, and obtain dependable measurement accuracy for the life of those products.

#### Agilent T&M Software and Connectivity

Agilent's Test and Measurement software and connectivity products, solutions and developer network allows you to take time out of connecting your instruments to your computer with tools based on PC standards, so you can focus on your tasks, not on your connections. Visit [www.agilent.com/find/connectivity](http://www.agilent.com/find/connectivity) for more information.

#### By internet, phone, or fax, get assistance with all your test & measurement needs

##### Phone or Fax

**United States:**  
(tel) 800 452 4844

**Canada:**  
(tel) 877 894 4414  
(fax) 905 282 6495

**China:**  
(tel) 800 810 0189  
(fax) 800 820 2816

**Europe:**  
(tel) (31 20) 547 2323  
(fax) (31 20) 547 2390

**Japan:**  
(tel) (81) 426 56 7832  
(fax) (81) 426 56 7840

##### Korea:

(tel) (82 2) 2004 5004  
(fax) (82 2) 2004 5115

##### Latin America:

(tel) (305) 269 7500  
(fax) (305) 269 7599

##### Taiwan:

(tel) 0800 047 866  
(fax) 0800 286 331

##### Other Asia Pacific

**Countries:**  
(tel) (65) 6375 8100  
(fax) (65) 6836 0252

Email:  
[tm\\_asia@agilent.com](mailto:tm_asia@agilent.com)

#### Online Assistance:

[www.agilent.com/find/assist](http://www.agilent.com/find/assist)

Product specifications and descriptions in this document subject to change without notice.

© Agilent Technologies, Inc. 2001, 2003  
Printed in USA, May 13, 2003  
5965-9340E



Agilent Technologies